

Robótica Educativa: Ensamble Traslador de Árboles

Cuidemos nuestros
recursos naturales

4to grado de primaria

Ciencias de la naturaleza

ROBÓTICA
EDUCATIVA

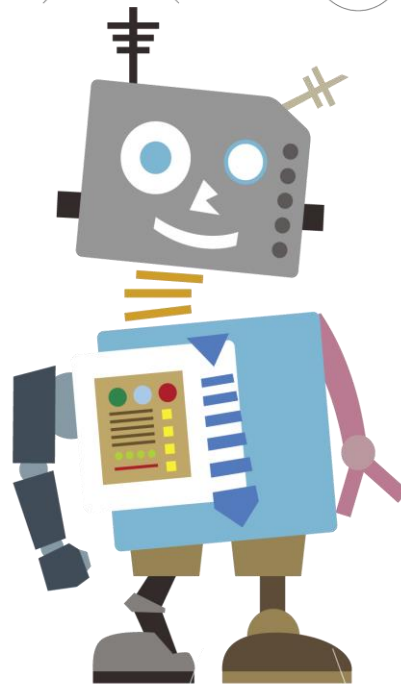

Traslador de árboles

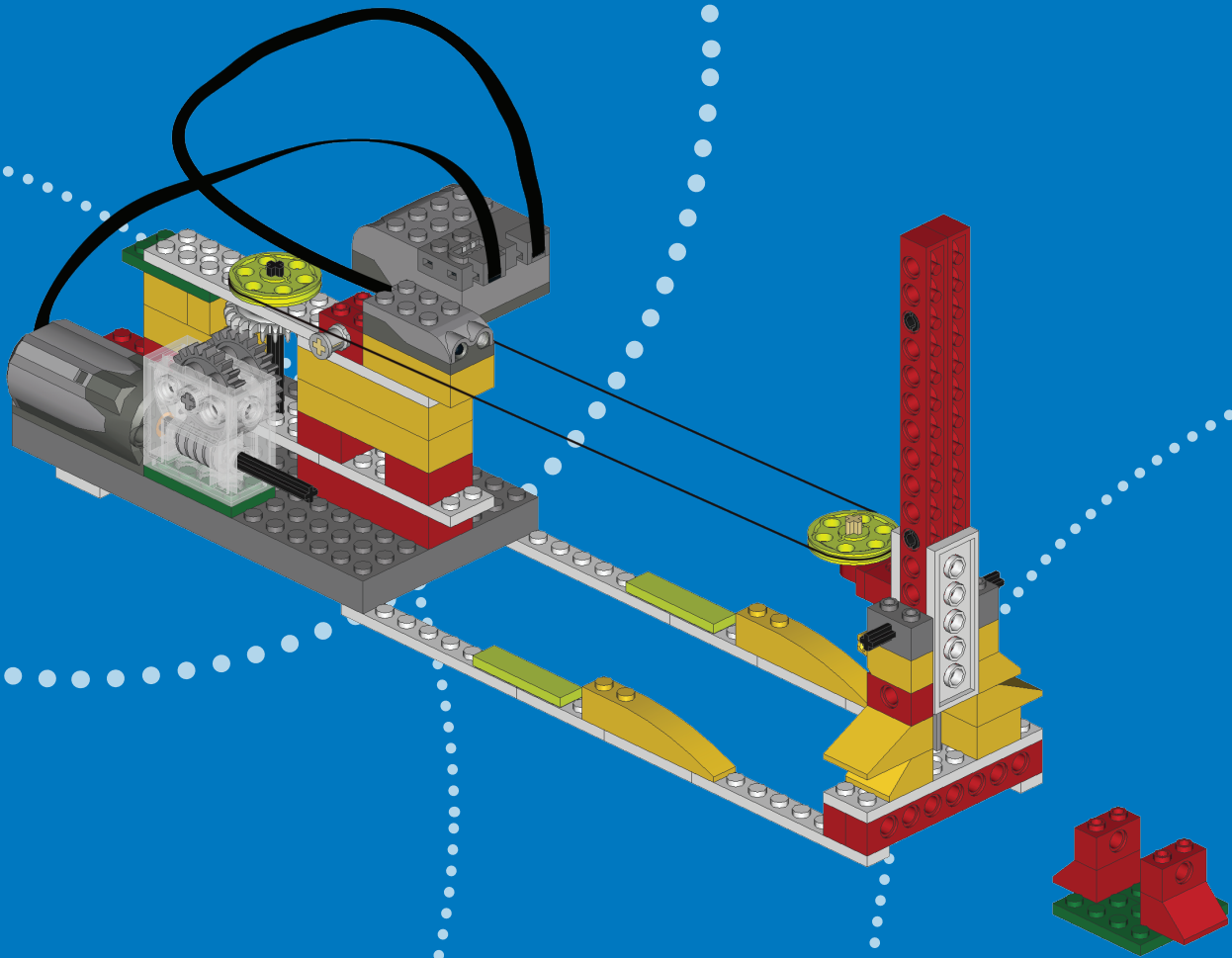

1

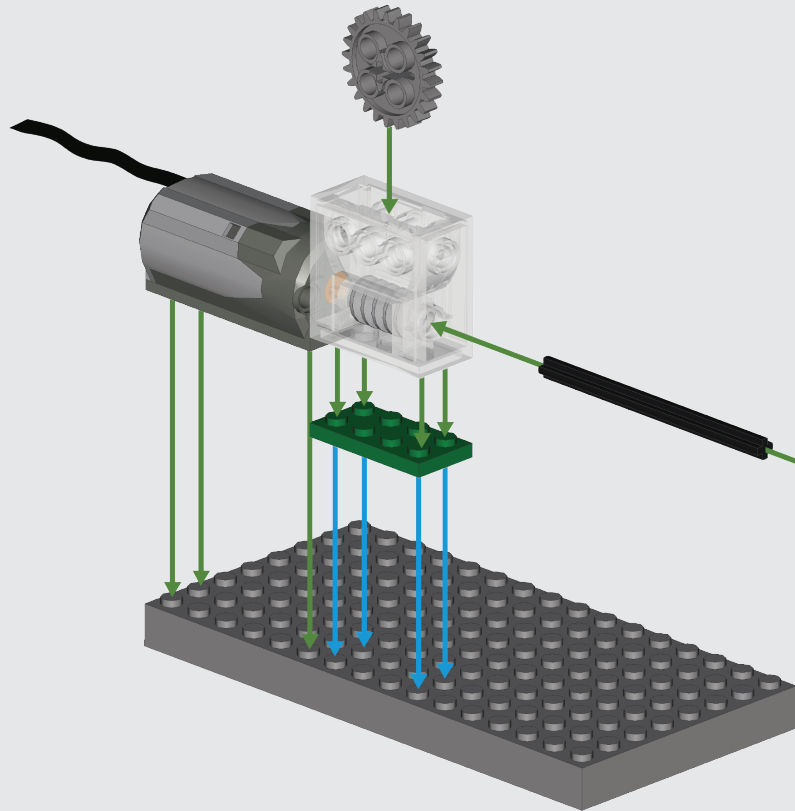
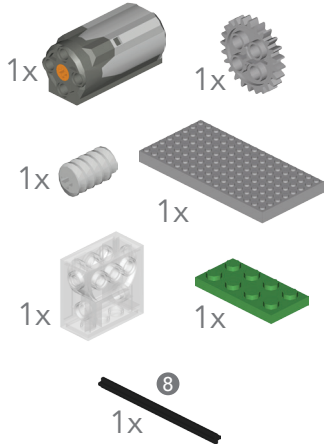

2

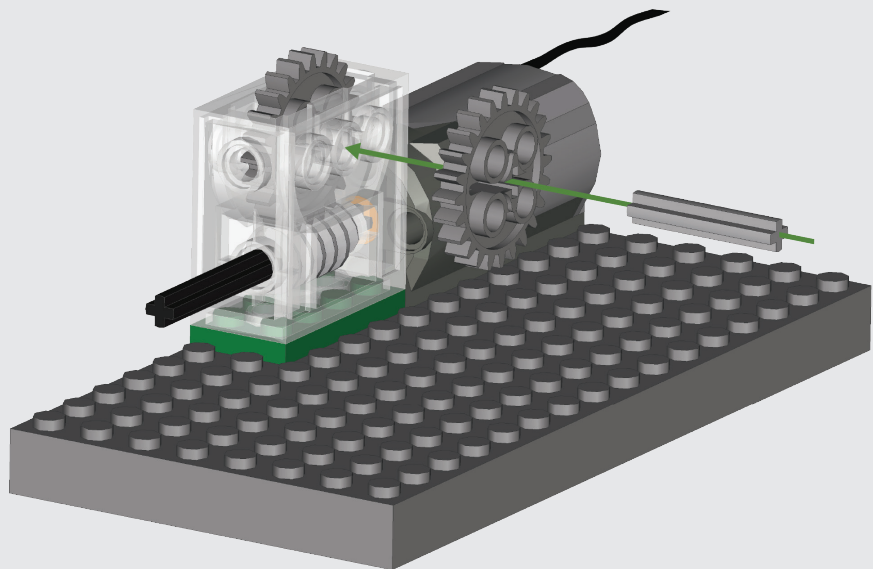

3

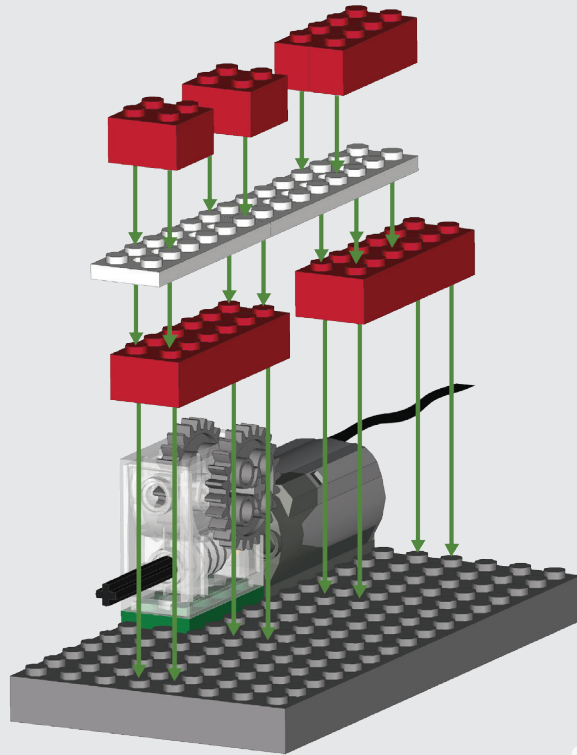
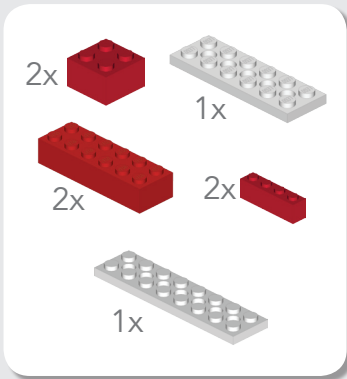



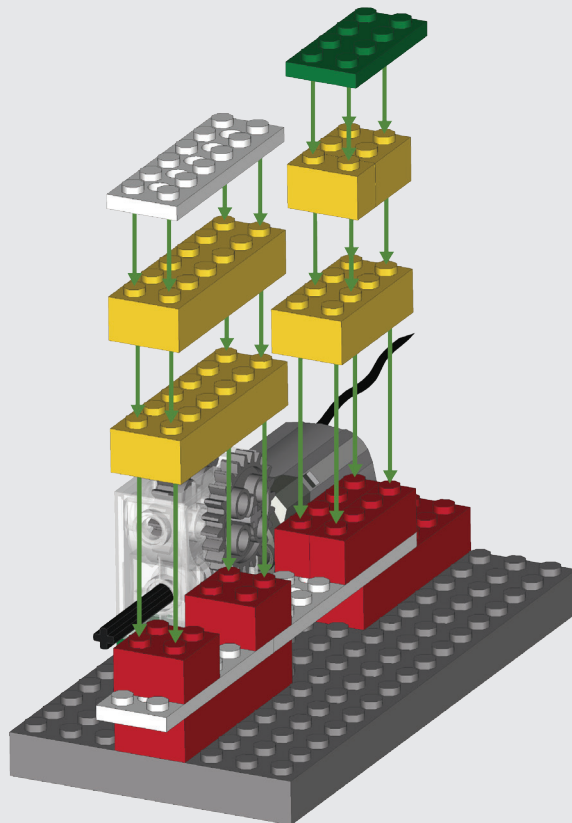
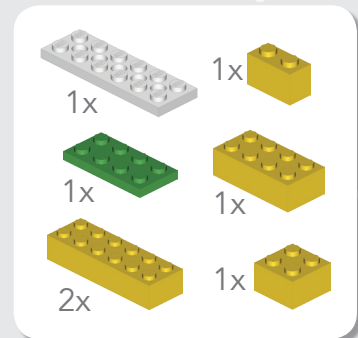

4

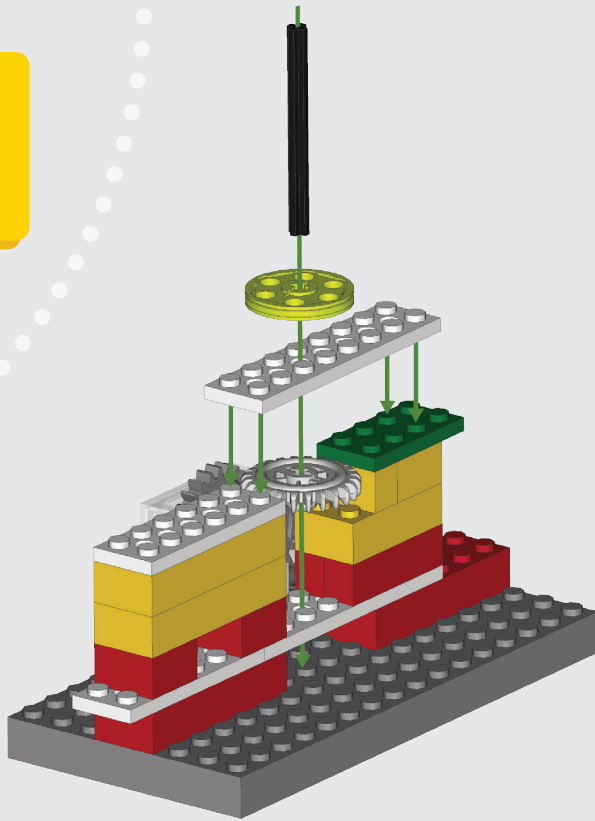



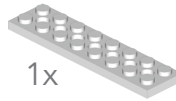

5

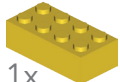

- 1x 
- 1x 
- 1x 
- 1x 

6

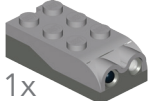
- 2x 
- 2x 
- 1x 
- 2x 
- 1x 

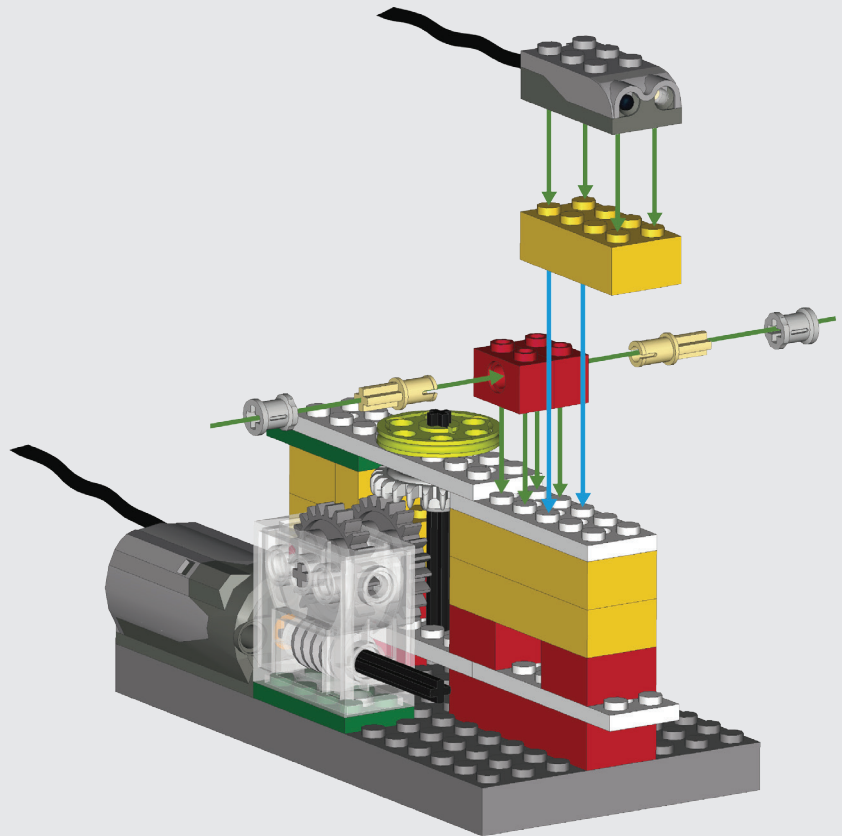

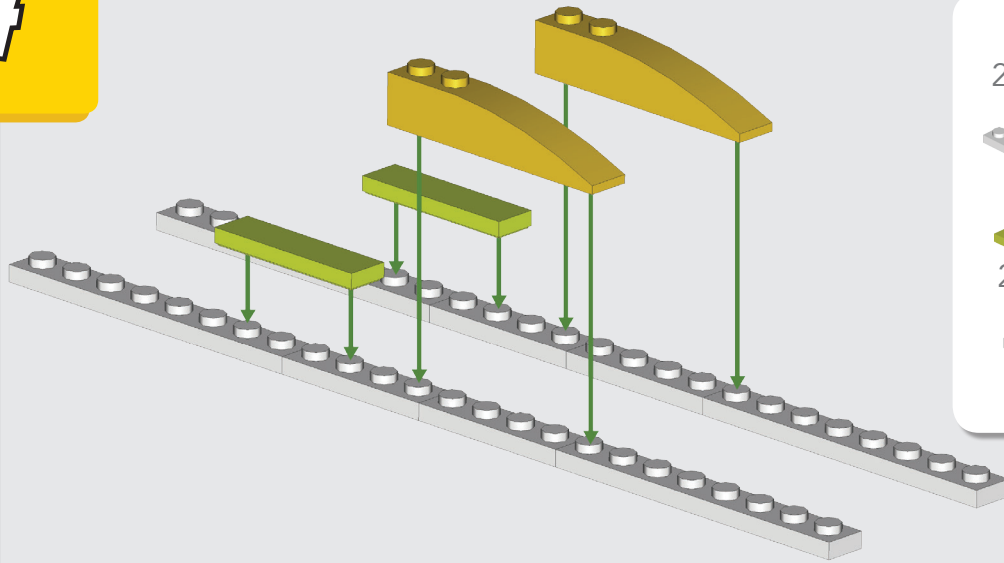

7

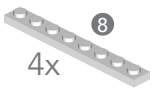

2x 

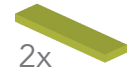
4x 

2x 

4x 

8

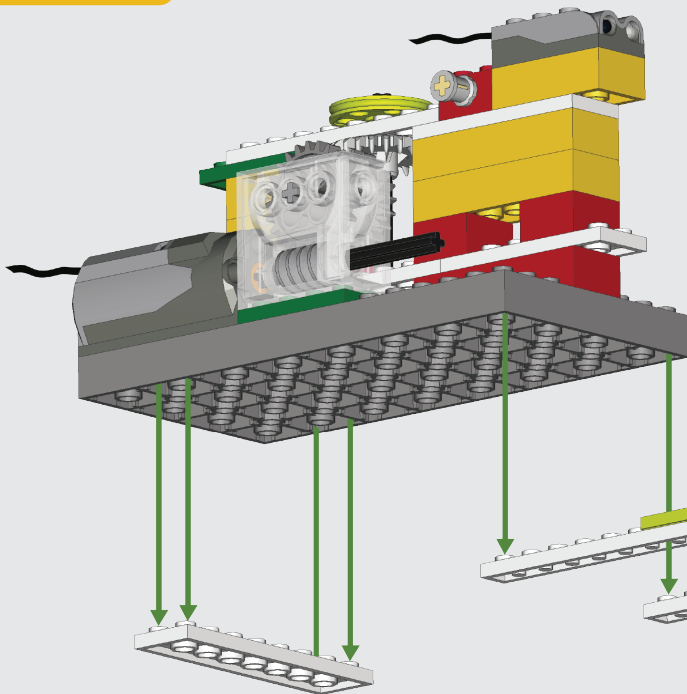

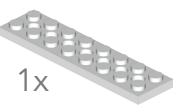

1x 

9

2x  2x 

2x  1x 

2x  1x 

2x  1x 

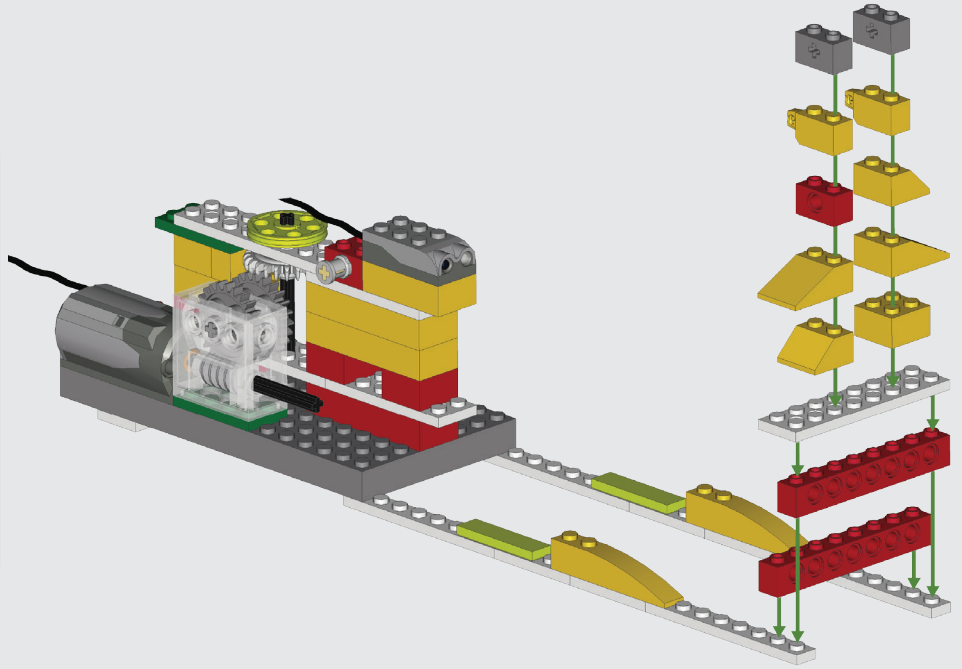

10

2x 

2x 

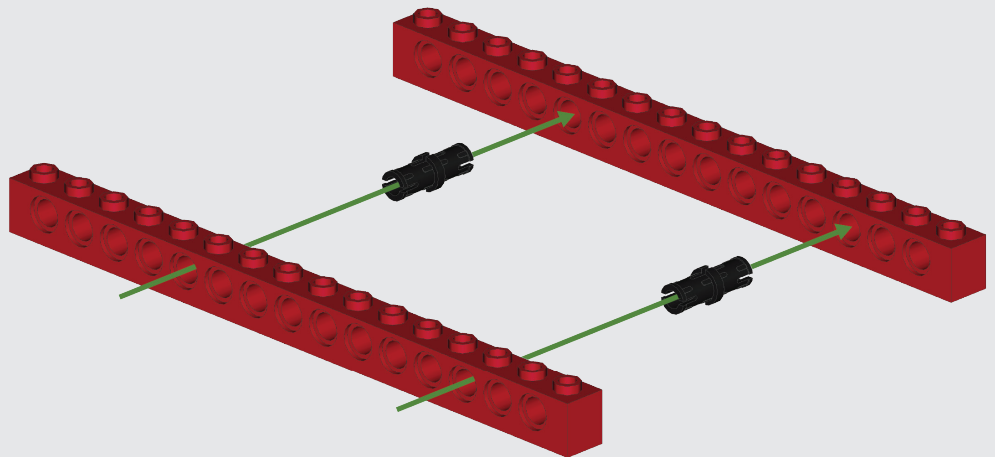

13

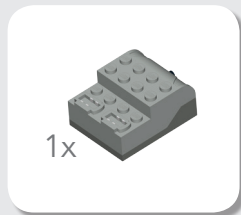
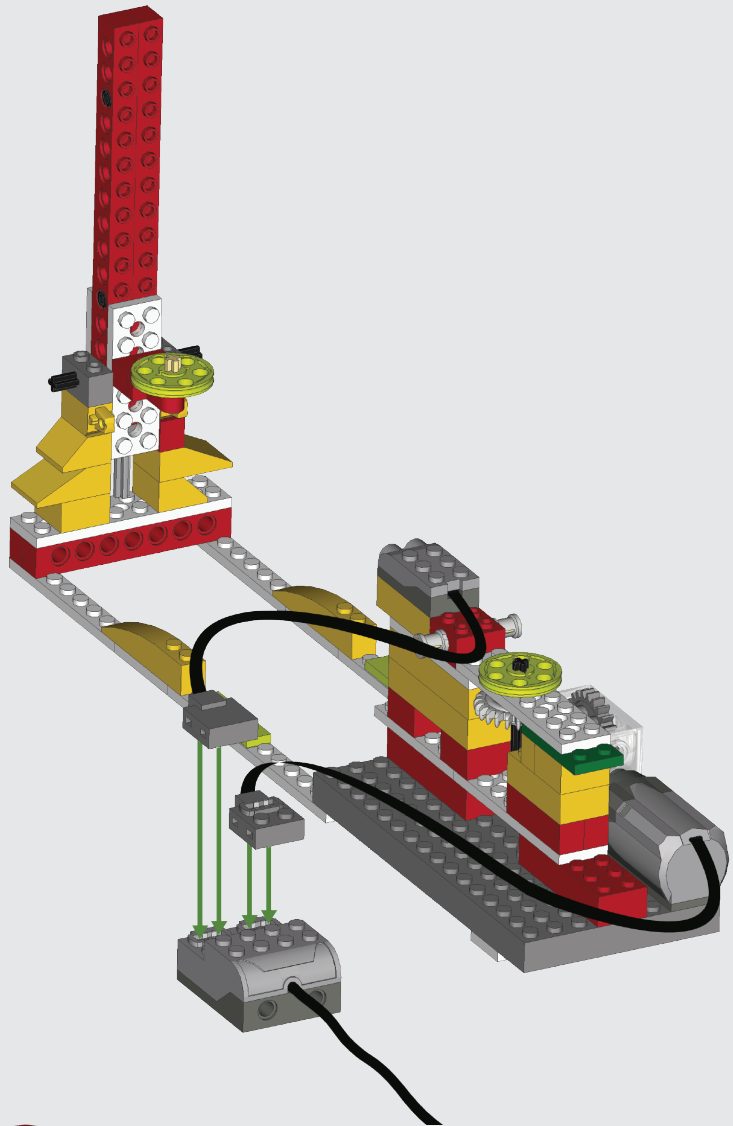

14

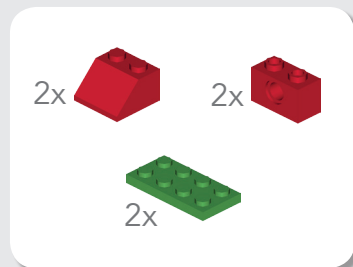
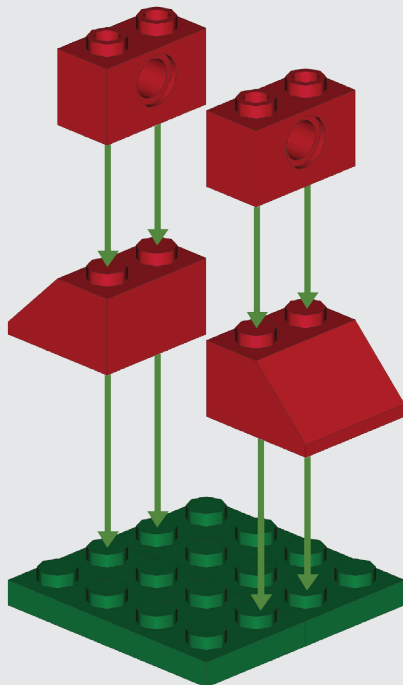

Resultado final

